

TECHNISCHE BESCHREIBUNG

FARBE

OBERPLATTE - GLAS



WEISS, GLAS
LACOBEL

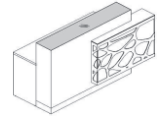

KORPUS

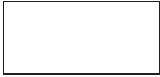

67 WEISS PASTELL

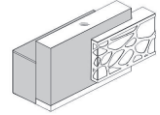

FRONT - METALL

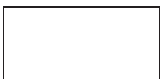

15 WEISS GLANZ

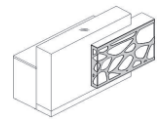

FRONT - PLEXIGLAS

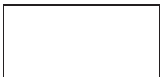

PLEXIGLAS WEISS

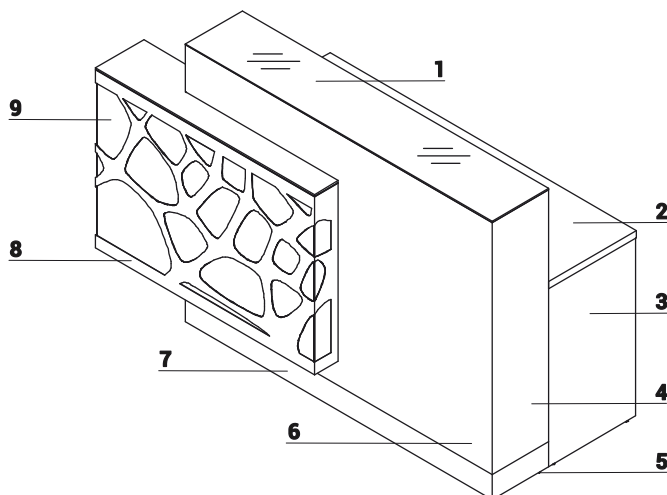
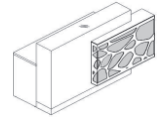

1. **Glasplatte** - Lacobel - Glas 4mm
2. **Arbeitsplatte** - Melaminplatte 28mm, Umleimer PVC
3. **Front** - Metallelement (pulverbeschichtet) mit Plexiglas verbunden
4. **RGBW LED** - Beleuchtung, Fernsteuerung
5. **Niedrige Seite** - Melaminplatte 28mm, Umleimer PVC
6. **HPL** - Sockel in Aluminium gebürstet
7. **Korpus** - Melaminplatte 18mm, mit HPL - Matt
8. **Front** - Melaminplatte 28mm + HPL- Matt 0,8mm
9. **Höhenregulierung** - 5mm

TECHNISCHE BESCHREIBUNG

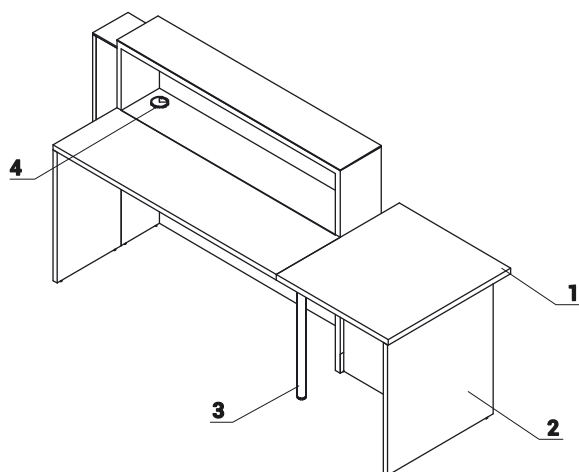

1. **Arbeitsplatte** - Melaminplatte 28mm, Umleimer PVC
2. **Niedrige Seite** - Melaminplatte 28mm, Umleimer PVC
3. **Stützfuß NL41** - aus Metall,
bei Verbindung der Platten notwendig
4. **Kabeldurchlässe** - ø80mm

ABMESSUNGEN

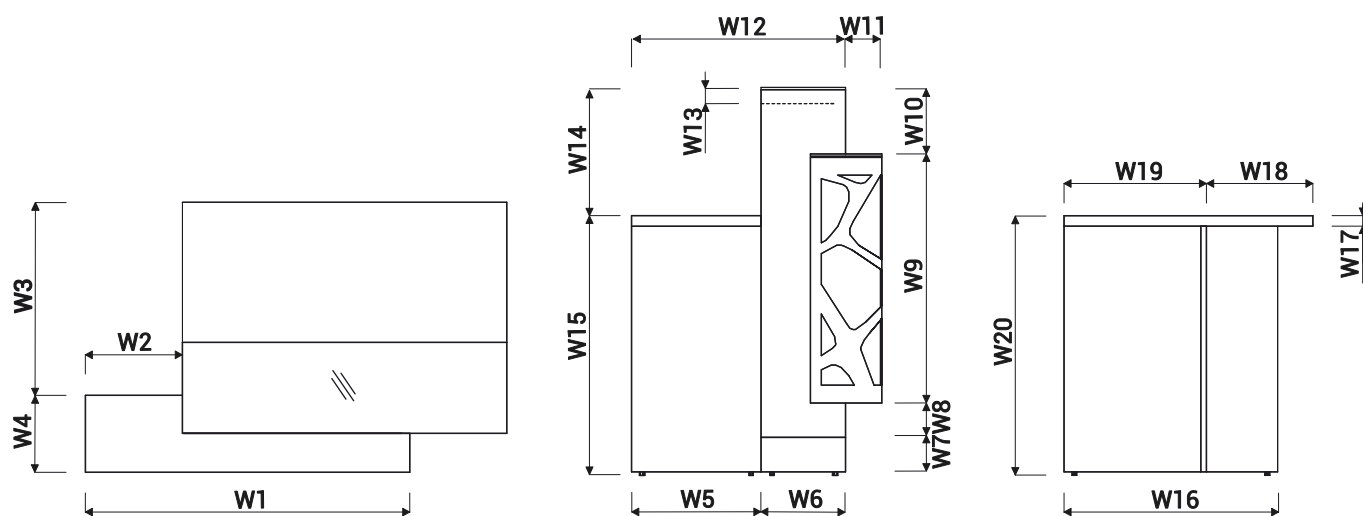

W1 - 1000mm | W2 - 300mm | W3 - 550mm | W4 - 222mm | W5 - 400mm | W6 - 260mm | W7 - 100mm | W8 - 97mm | W9 - 705mm | W10 - 184mm |
W11 - 110mm | W12 - 660mm | W13 - 34mm | W14 - 365mm | W15 - 740mm | W16 - 660mm | W17 - 28mm | W18 - 318mm | W19 - 452mm | W20 -
740mm

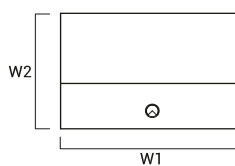
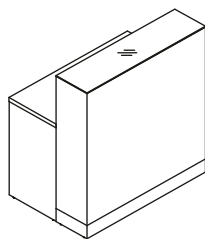
EMPFANGSTHEKEN-SYSTEME

INDEX SYMBOL	ABMESSUNGEN [mm]									KOMPONENTEN
	W ₁	W ₂	D ₁	D ₂	H		kg	m ³	pcs	
LOG10G	1000	660	-	-	1105		50.0	0.582	2	LOG10B+LOG10K
LOG14G	1400	660	-	-	1105		55.0	0.815	2	LOG14B+LOG14K

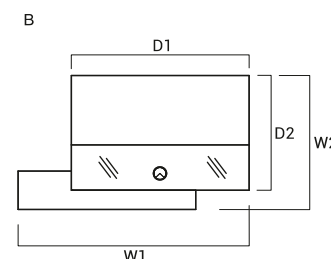
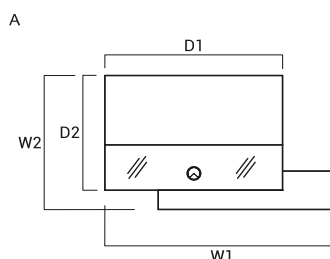
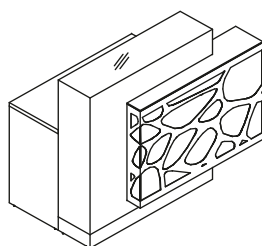

INDEX SYMBOL	ABMESSUNGEN [mm]									KOMPONENTEN
	W ₁	W ₂	D ₁	D ₂	H		kg	m ³	pcs	
A LOG11LG	1300	770	1000	660	1105		75.5	0.740	4	LOG10B+LOG10K+LOG01L
B LOG11PG	1300	770	1000	660	1105		75.5	0.740	4	LOG10B+LOG10K+LOG01P

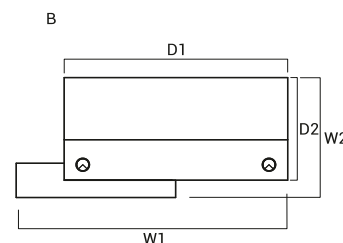
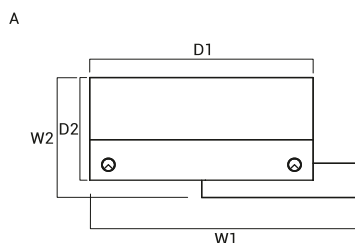
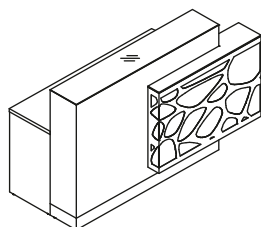

INDEX SYMBOL	ABMESSUNGEN [mm]									KOMPONENTEN
	W ₁	W ₂	D ₁	D ₂	H		kg	m ³	pcs	
A LOG12LG	1700	770	1400	660	1105		80.5	0.973	4	LOG14B+LOG14K+LOG01L
B LOG12PG	1700	770	1400	660	1105		80.5	0.973	4	LOG14B+LOG14K+LOG01P

LEGENDE

NETTOGEWICHT

VOLUMEN

STÜCKZAHL DER PAKETE

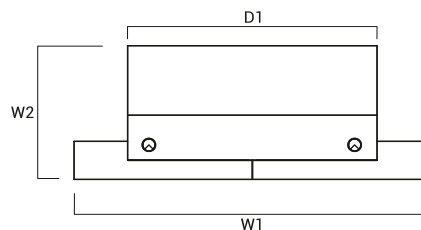
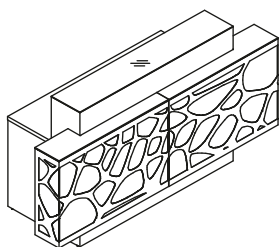
EMPFANGSTHEKEN-SYSTEME

INDEX SYMBOL	ABMESSUNGEN [mm]										KOMPONENTEN
	W ₁	W ₂	D ₁	D ₂	H						
LOG13G	2000	770	1400	-	1105		106.0	1.132	6		LOG14B+LOG14K+LOG01L +LOG01P

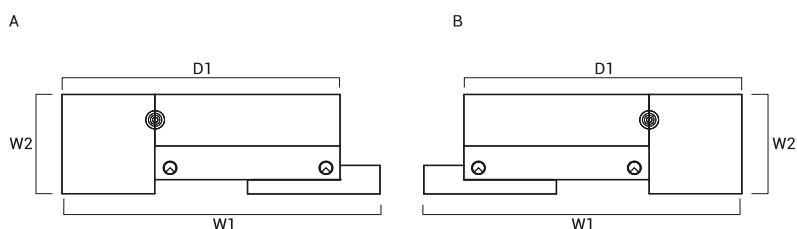
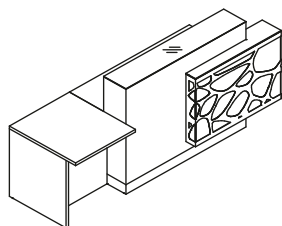

INDEX SYMBOL	ABMESSUNGEN [mm]										KOMPONENTEN
	W ₁	W ₂	D ₁	D ₂	H						
A LOG14PLG	2400	770	2100	-	1105		93.8	1.007	6		LOG01L+LOG14K+LOG14B +LOG07+NE41L
B LOG14PPG	2400	770	2100	-	1105		93.8	1.007	6		LOG07L+LOG14B+LOG14K +LOG01P+NE41L

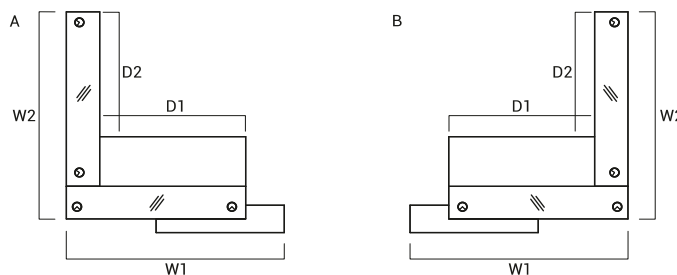
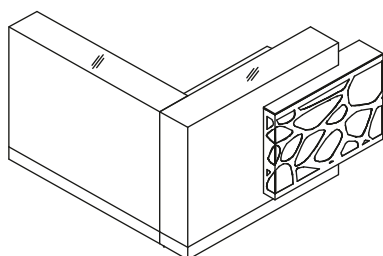

INDEX SYMBOL	ABMESSUNGEN [mm]										KOMPONENTEN
	W ₁	W ₂	D ₁	D ₂	H						
A LOG16LG	1700	1660	1140	1000	1105		120.5	1.297	5		LOG01L+2xLOG14K+LOG11B
B LOG16PG	1700	1770	-	-	1105		120.5	1.297	5		2xLOG14K+LOG11B+LOG01P

LEGENDE

NETTOGEWICHT

VOLUMEN

STÜCKZAHL DER PAKETE

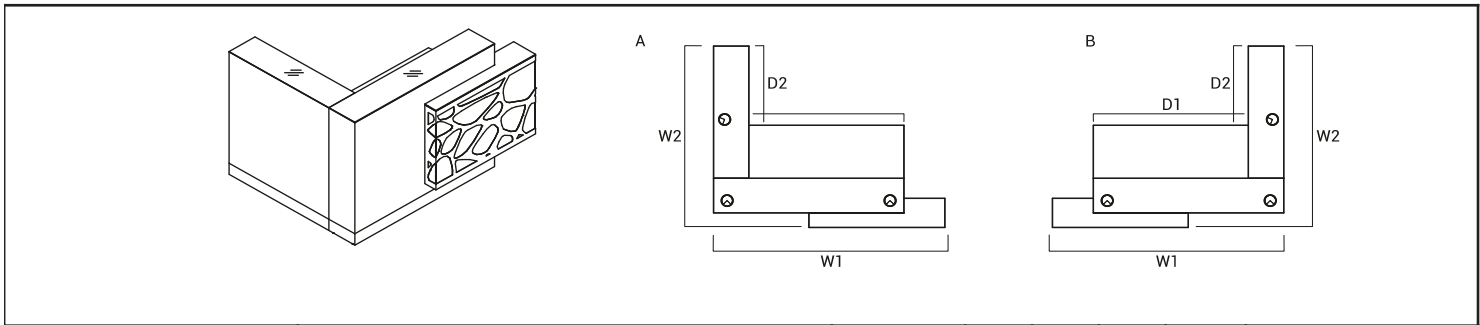
EMPFANGSTHEKEN-SYSTEME

INDEX SYMBOL	ABMESSUNGEN [mm]										KOMPONENTEN
	W ₁	W ₂	D ₁	D ₂	H						
A LOG18LG	1700	1370	1140	600	1105		115.5	1.182	5		LOG01L+LOG14K+LOG11B+LOG10K
B LOG18PG	1700	1370	-	-	1105		115.5	1.182	5		LOG10K+LOG11B+LOG14K+LOG01P

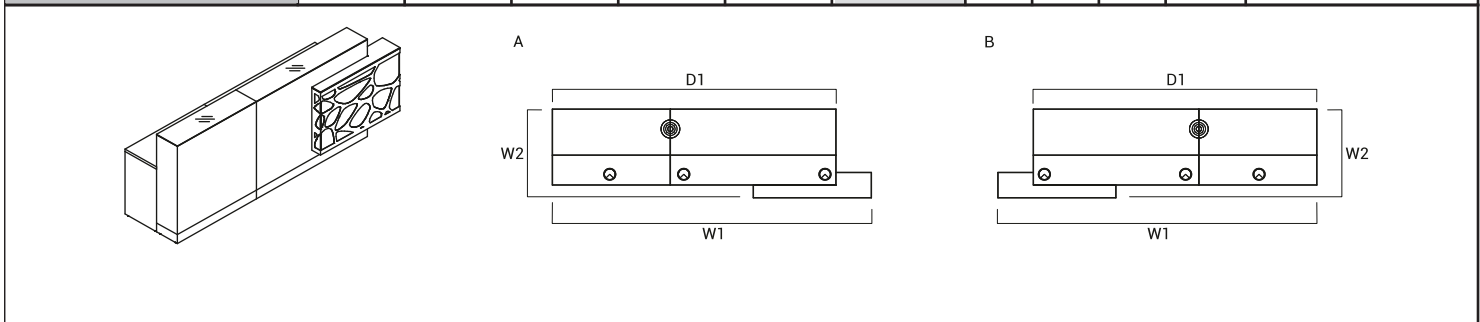

INDEX SYMBOL	ABMESSUNGEN [mm]										KOMPONENTEN
	W ₁	W ₂	D ₁	D ₂	H						
A LOG19LG	2700	770	2400	-	1105		131.8	1.557	7		LOG01L+LOG14K+LOG10K+LOG14B+LOG10B+NE41L
B LOG19PG	2700	770	2400	-	1105		131.8	1.557	7		LOG10B+LOG14B+LOG10K+LOG14K+LOG01P+NE41L

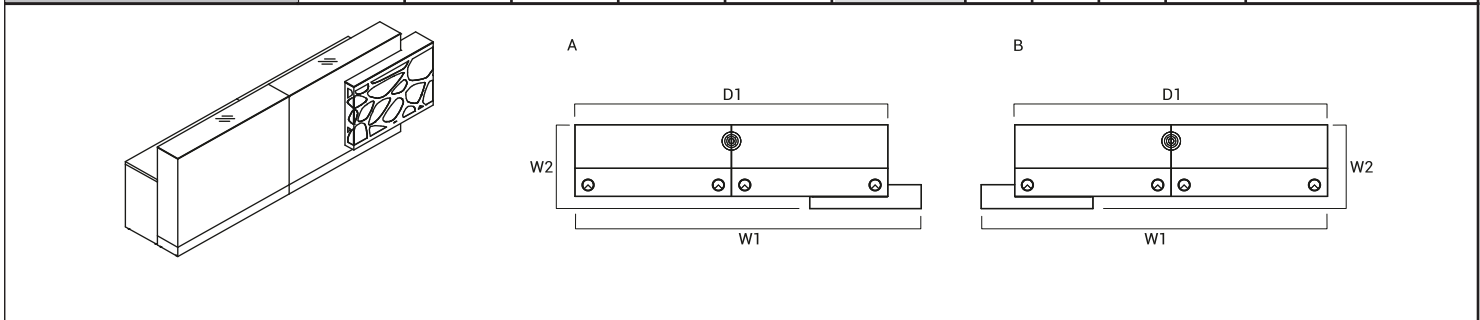

INDEX SYMBOL	ABMESSUNGEN [mm]										KOMPONENTEN
	W ₁	W ₂	D ₁	D ₂	H						
A LOG20LG	3100	770	2800	-	1105		136.8	1.790	7		LOG01L+2xLOG14K+2xLOG14B+NE41L
B LOG20PG	3100	770	2800	-	1105		136.8	1.790	7		2xLOG14B+2xLOG14K+LOG01P+NE41L

LEGENDE

NETTOGEWICHT

VOLUMEN

STÜCKZAHL DER PAKETE

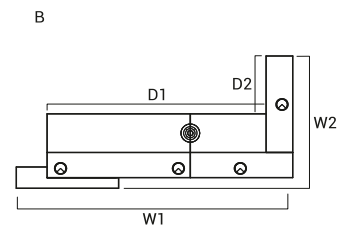
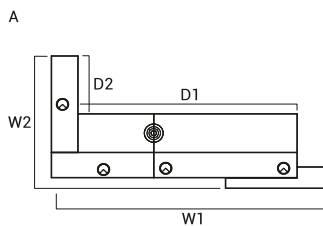
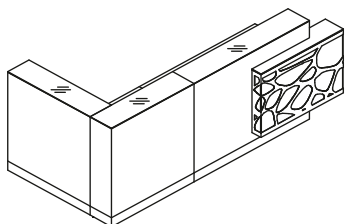
EMPFANGSTHEKEN-SYSTEME

INDEX SYMBOL	ABMESSUNGEN [mm]									KOMONENTEN
	W ₁	W ₂	D ₁	D ₂	H		kg	m ³	pcs	
A LOG21LG	2700	1370	2140	600	1105		162.8	1.555	8	LOG01L+LOG14K+2xLOG10K+LOG14B+LOG08B+NE41L
B LOG21PG	2700	1370	2140	600	1105		162.8	1.555	8	2xLOG10K+LOG08B+LOG14B+LOG14K+LOG01P+NE41L

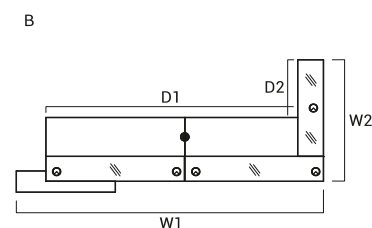
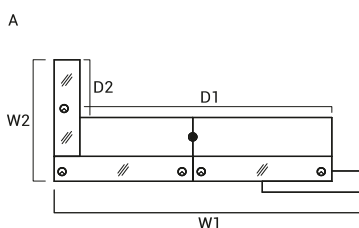
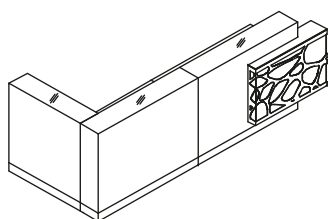

INDEX SYMBOL	ABMESSUNGEN [mm]									KOMONENTEN
	W ₁	W ₂	D ₁	D ₂	H		kg	m ³	pcs	
A LOG22LG	3100	1370	2540	600	1105		171.8	1.999	8	LOG01L+2xLOG14K+LOG14B+LOG11B+LOG10K+NE41L
B LOG22PG	3100	1370	2540	600	1105		171.8	1.999	8	LOG10K+LOG11B+LOG14B+2xLOG14K+LOG01P+NE41L

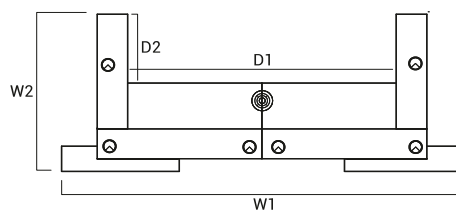
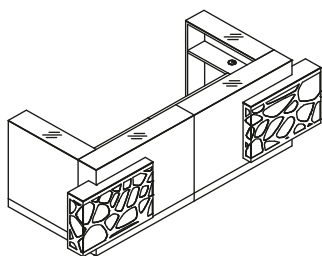

INDEX SYMBOL	ABMESSUNGEN [mm]									KOMONENTEN
	W ₁	W ₂	D ₁	D ₂	H		kg	m ³	pcs	
LOG23G	3400	1370	2280	600	1105		232.3	2.366	11	2xLOG10K+2xLOG11B+2xLOG14K+LOG01L+LOG01P+NE41L

LEGENDE

NETTOGEWICHT

VOLUMEN

STÜCKZAHL DER PAKETE

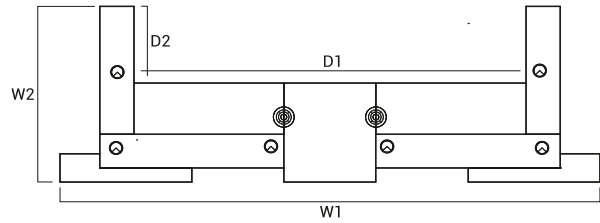
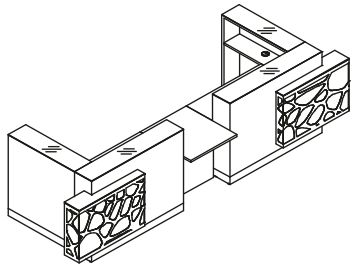
EMPFANGSTHEKEN-SYSTEME

INDEX SYMBOL	ABMESSUNGEN [mm]									KOMPONENTEN
	W ₁	W ₂	D ₁	D ₂	H		kg	m ³	pcs	
LOG24G	4100	1370	-	-	1105		245.6	2.401	13	2xLOG10K+2xLOG14K+2xLOG11B +LOG07+LOG01L+LOG01P +2xNE41L

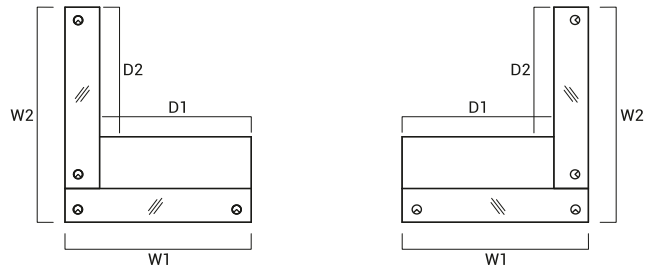
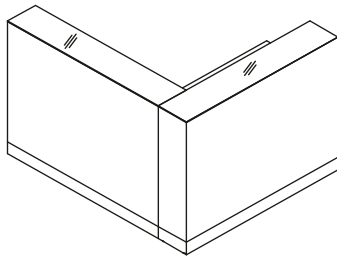

INDEX SYMBOL	ABMESSUNGEN [mm]									KOMPONENTEN
	W ₁	W ₂	D ₁	D ₂	H		kg	m ³	pcs	
LOG15	1400	1660	-	-	1105		95.0	1.138	3	2xLOG14K+LOG11B

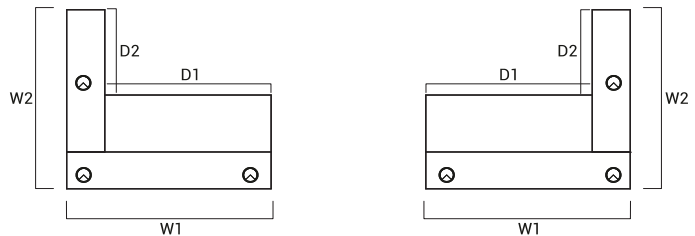
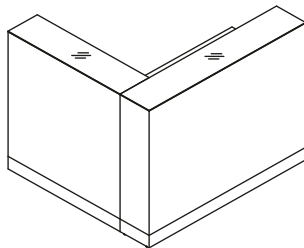

INDEX SYMBOL	ABMESSUNGEN [mm]									KOMPONENTEN
	W ₁	W ₂	D ₁	D ₂	H		kg	m ³	pcs	
LOG17	1400	1260	-	-	1105		90.0	1.024	3	LOG11B+LOG14K+LOG10K

LEGENDE

NETTOGEWICHT

VOLUMEN

STÜCKZAHL DER PAKETE

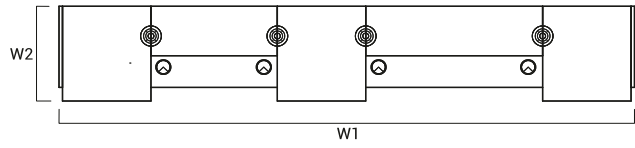
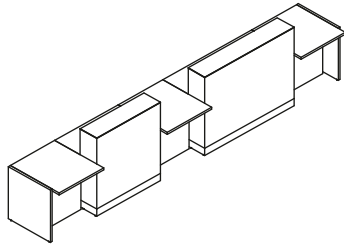
EMPFANGSTHEKEN-SYSTEME

INDEX SYMBOL	ABMESSUNGEN [mm]										KOMPONENTEN
	W ₁	W ₂	D ₁	D ₂	H						
LOG25	4556	770	-	-	1105		146.2	1.501	11		3xLOG07+LOG14B+LOG14K +LOG10B+LOG10K+4xNE41L

LEGENDE

NETTOGEWICHT

VOLUMEN

STÜCKZAHL DER PAKETE

PRODUKTANSICHT UND SKIZZE	ABMESSUNGEN [mm]			INDEX SYMBOL						KOMPONENTEN
	BREITE	TIEFE	HÖHE			kg	m ³	pcs		

BESTANDTEILE

	728	770	740	LOG07		13.3	0.034	2		Universalelement
	1000	220	710	LOG01P		25.5	0.158	2		Rechts
	1000	220	710	LOG01L		25.5	0.158	2		Links
	1000	260	1105	LOG10K		35.0	0.286	1		
	1400	260	1105	LOG14K		40.0	0.400	1		
	740	400	28	LOG08B		11.0	0.008	1		
	1000	400	740	LOG10B		15.0	0.296	1		
	1140	400	740	LOG11B		15.0	0.337	1		
	1400	400	740	LOG14B		15.0	0.414	1		
	40	40	712	NE41L		1.5	0.002	1		Rundfuß

LEGENDE

NETTOGEWICHT

VOLUMEN

STÜCKZAHL DER PAKETE